

Main Product Characteristics

BV_{DSS}	-40V
$R_{DS(ON)}$	105m Ω (Max)
I_D	-3A

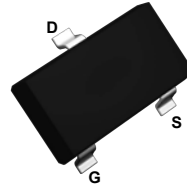

SOT-23

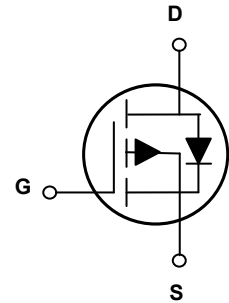

Schematic Diagram

Features and Benefits

- Advanced MOSFET process technology
- Ideal for high efficiency switched mode power supplies
- Low on-resistance with low gate charge
- Fast switching and reverse body recovery



Description

The GSFC04031 utilizes the latest techniques to achieve high cell density and low on-resistance. These features make this device extremely efficient and reliable for use in high efficiency switch mode power supplies and a wide variety of other applications.

Absolute Maximum Ratings ($T_C=25^{\circ}\text{C}$ unless otherwise specified)

Parameter	Symbol	Max.	Unit
Drain-Source Voltage	V_{DS}	-40	V
Gate-Source Voltage	V_{GS}	± 20	V
Drain Current-Continuous ($T_A=25^{\circ}\text{C}$)	I_D	-3	A
Drain Current-Continuous ($T_A=70^{\circ}\text{C}$)		-2.4	
Drain Current-Pulsed ¹	I_{DM}	-12	A
Power Dissipation ($T_A=25^{\circ}\text{C}$)	P_D	1.56	W
Power Dissipation-De-rate above 25 $^{\circ}\text{C}$		0.0125	
Thermal Resistance, Junction-to-Ambient	$R_{\theta JA}$	80	$^{\circ}\text{C}/\text{W}$
Operating Junction Temperature Range	T_J	-55 To +150	$^{\circ}\text{C}$
Storage Temperature Range	T_{STG}	-55 To +150	$^{\circ}\text{C}$

Electrical Characteristics ($T_J=25^\circ\text{C}$ unless otherwise specified)

Parameter	Symbol	Conditions	Min.	Typ.	Max.	Unit
On / Off Characteristics						
Drain-Source Breakdown Voltage	BV_{DSS}	$V_{GS}=0V, I_D=-250\mu A$	-40	-	-	V
Drain-Source Leakage Current	I_{DSS}	$V_{DS}=-40V, V_{GS}=0V, T_J=25^\circ\text{C}$	-	-	-1	μA
		$V_{DS}=-32V, V_{GS}=0V, T_J=125^\circ\text{C}$	-	-	-10	μA
Gate-Source Leakage Current	I_{GSS}	$V_{GS}=\pm 20V, V_{DS}=0V$	-	-	± 100	nA
Static Drain-Source On-Resistance	$R_{DS(ON)}$	$V_{GS}=-10V, I_D=-2A$	-	88	105	m Ω
		$V_{GS}=-4.5V, I_D=-1.5A$	-	128	166	
Gate Threshold Voltage	$V_{GS(th)}$	$V_{GS}=V_{DS}, I_D=-250\mu A$	-1.2	-1.8	-2.5	V
Forward Transconductance	g_{fs}	$V_{DS}=-10V, I_D=-2A$	-	4	-	S
Dynamic and Switching Characteristics						
Total Gate Charge ^{2,3}	Q_g	$V_{DS}=-20V, I_D=-1.5A, V_{GS}=-10V$	-	3	-	nC
Gate-Source Charge ^{2,3}	Q_{gs}		-	0.2	-	
Gate-Drain Charge ^{2,3}	Q_{gd}		-	1.2	-	
Turn-On Delay Time ^{2,3}	$t_{d(on)}$	$V_{DD}=-20V, R_G=6\Omega, V_{GS}=-10V, I_D=-1.5A$	-	2.9	-	nS
Rise Time ^{2,3}	t_r		-	8.4	-	
Turn-Off Delay Time ^{2,3}	$t_{d(off)}$		-	19.2	-	
Fall Time ^{2,3}	t_f		-	5.6	-	
Input Capacitance	C_{iss}	$V_{DS}=-20V, V_{GS}=0V, F=1\text{MHz}$	-	310	-	pF
Output Capacitance	C_{oss}		-	35	-	
Reverse Transfer Capacitance	C_{rss}		-	24	-	
Gate Resistance	R_g	$V_{GS}=0V, V_{DS}=0V, F=1\text{MHz}$	-	16	-	Ω
Drain-Source Diode Characteristics and Maximum Ratings						
Continuous Source Current	I_S	$V_G=V_D=0V,$	-	-	-3	A
Pulsed Source Current	I_{SM}	Force Current	-	-	-6	A
Diode Forward Voltage	V_{SD}	$V_{GS}=0V, I_S=-1A, T_J=25^\circ\text{C}$	-	-	-1	V

Note:

1. Repetitive rating: Pulsed width limited by maximum junction temperature.
2. Pulse test: pulse width $\leq 300\mu s$, duty cycle $\leq 2\%$.
3. Essentially independent of operating temperature.

Typical Electrical and Thermal Characteristic Curves

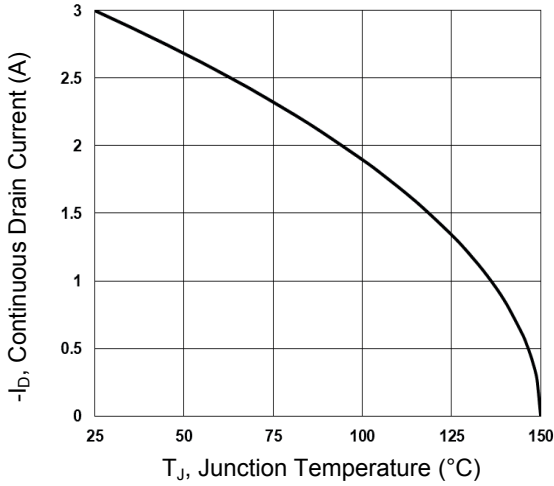

Figure 1. Continuous Drain Current vs. T_J

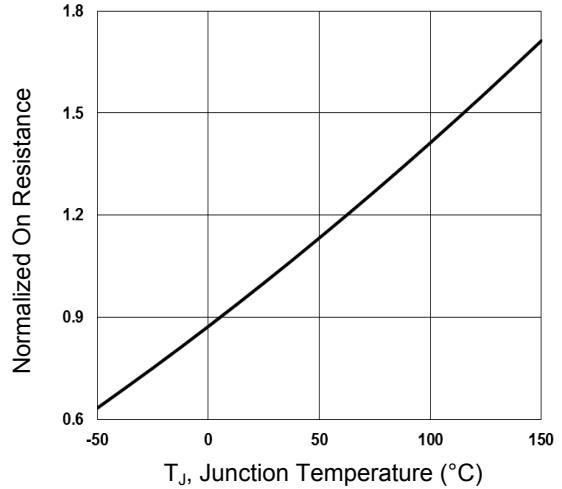

Figure 2. Normalized $R_{DS(on)}$ vs. T_J

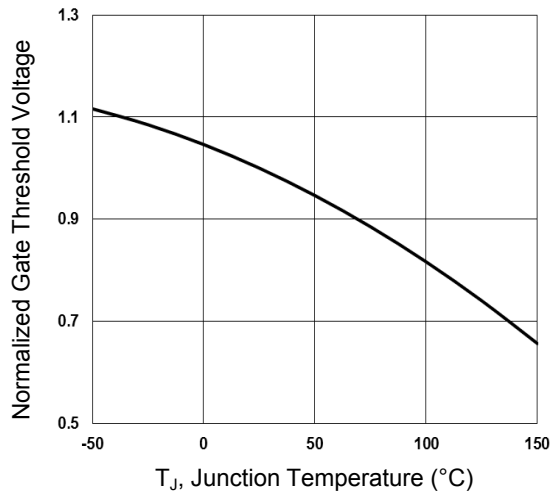

Figure 3. Normalized V_{th} vs. T_J

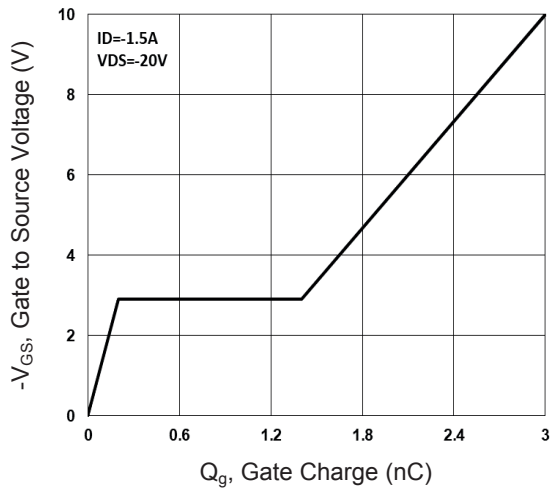

Figure 4. Gate Charge Characteristics

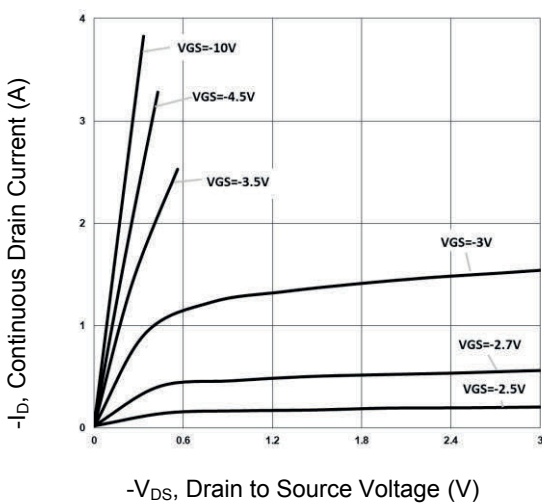

Figure 5. Typical Output Characteristics

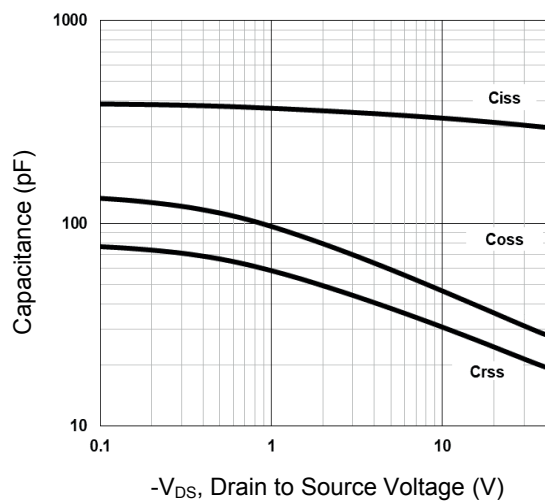

Figure 6. Capacitance Characteristics

Typical Electrical and Thermal Characteristic Curves

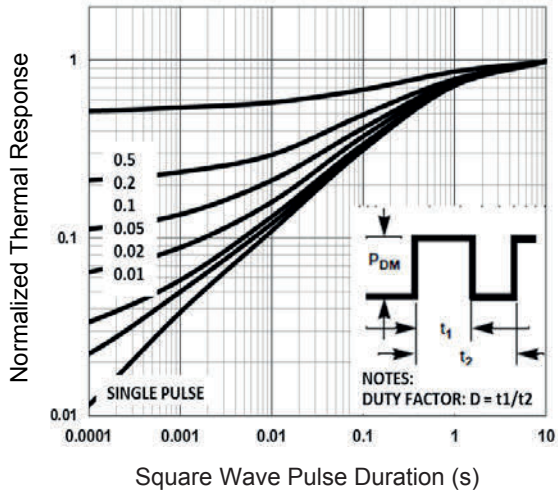

Figure 7. Normalized Transient Impedance

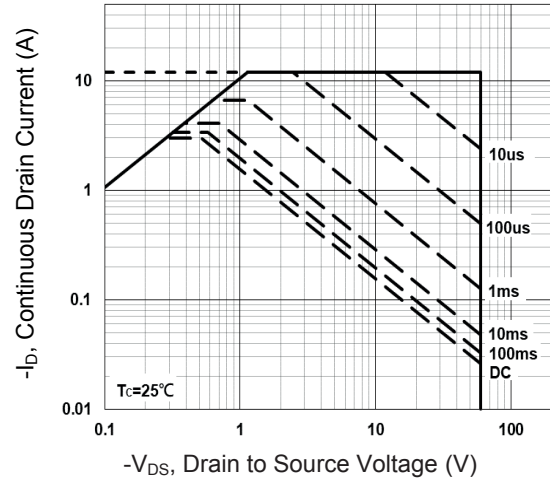
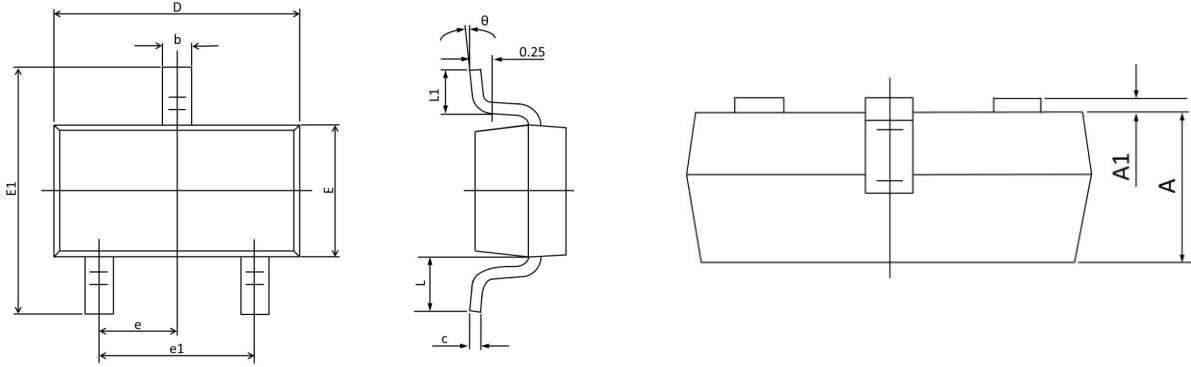

Figure 8. Maximum Safe Operation Area

Package Outline Dimensions (SOT-23)



Symbol	Dimensions in Millimeters		Dimensions in Inches	
	Min	Max	Min	Max
A	0.900	1.110	0.035	0.044
A1	0.001	0.100	0.000	0.004
b	0.300	0.500	0.012	0.020
c	0.080	0.180	0.003	0.008
D	2.800	3.040	0.110	0.120
E	1.200	1.400	0.047	0.055
E1	2.100	2.640	0.080	0.104
e	0.950 TYP.		0.037 TYP.	
e1	1.780	2.040	0.070	0.080
L	0.550 REF.		0.022 REF.	
L1	0.100	0.500	0.004	0.020
θ	1°	10°	1°	10°

Recommended Pad Layout

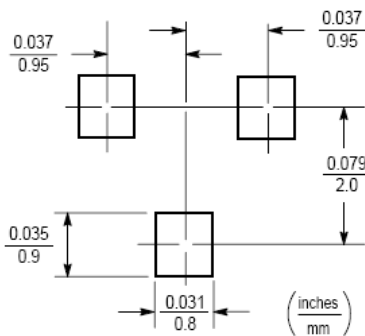

Notes:
 1. Tolerance ±0.10mm (4 mil) unless otherwise specified.

Order Information

Device	Package	Marking	Packaging	SPQ
GSFC04031	SOT-23	C4099	Tape & Reel	3,000 Pcs / Reel

For more information, please contact us at: inquiry@goodarksemi.com