

For single-phase circuit

### ◆ MAJOR USES

- AC/DC Common mode filter

### ◆ FEATURES

- Greatly improved inductance (10kHz, 100kHz).
- Improved impedance in the 150 kHz to 1 MHz frequency band when compared to the FL-V series coils.
- Deal with it by rated voltage 700V.
- Conforming to insulating type: B and incombustibility UL94V-0.

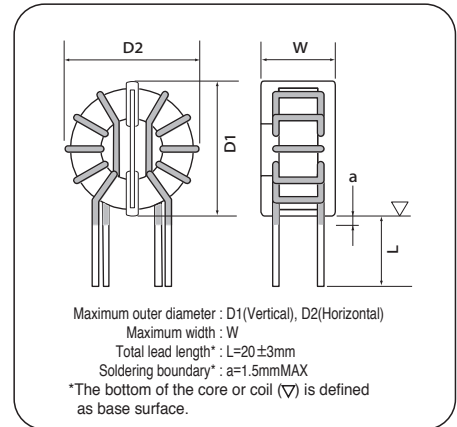

Coil Part No.	Core Part No.	Rated voltage [V]	Rated Current [A]	Inductance		D.C.R. mΩ (max)	Winding mm φ -lines	Outside Dimensions			Frequency Characteristics Graph	Temperature rise Graph
				10kHz [mH]	100kHz [mH]			D1 [mm]	D2 [mm]	W [mm]		
LDFW004272YS-V0E	F110705MDX	250	3.5	8.8	2.7	38.0	0.55-1P	15.0	16.0	12.0	1	A
LDFW006102YS-V0E			5.5	3.4	1.0	16.0	0.7-1P					
LDFW005402Y66V0E	F181205MDX	250	5	12.8	4.0	28.0	0.8-1P	24.5	26.5	16.5	2	B
LDFW007252Y66V0E			7	8.2	2.5	15.0	1.0-1P					
LDFW009192Y66V0E			8.5	6.2	1.9	10.5	1.1-1P					
LDFW011102Y66V0E			11	3.2	1.0	6.7	1.2-1P					
LDFW006832YD-V0E	F221407MDX	250	5.5	26.9	8.3	26.0	0.9-1P	27.0	31.0	17.5	3	C
LDFW009412YD-V0E			9	13.5	4.1	16.0	1.1-1P					
LDFW012282YD-V0E			12	9.1	2.8	9.5	1.3-1P					
LDFW014172YD-V0E			14	5.6	1.7	7.0	1.4-1P					
LDFW007652Y6-V0E	F221310MDX	250	7	21.0	6.5	22.0	1.0-1P	29.0	31.0	21.0	1	D
LDFW010302Y6-V0E			10	9.7	3.0	11.0	1.2-1P					
LDFW012202Y6-V0E			12	6.5	2.0	7.5	1.3-1P					
LDFW008123YV-V0E	F251513MDX	250	8	37.1	11.5	26.0	1.1-1P	30.5	34.0	23.5	2	E
LDFW011742YV-V0E			11	23.9	7.4	15.0	1.3-1P					
LDFW013412YV-V0E			13	13.2	4.1	10.0	1.4-1P					
LDFW016362Y8-V0E	F262115MDX	500	16	11.6	3.6	7.5	1.8-1P	34.0	37.0	27.5	3	F
LDFW023162Y8-V0E			23	5.2	1.6	3.7	2.1-1P					
LDFW028102Y8-V0E			28	3.2	1.0	2.5	1.6-2P					
LDFW015372YBUBV0E	F281815MUDX	700	15	11.9	3.7	6.7	1.7-1P	36.0	39.5	29.5	4	G
LDFW021252YBUBV0E			21	8.1	2.5	4.5	1.9-1P					
LDFW026152YBUBV0E			26	4.8	1.5	2.9	1.5-2P					
LDFW016732Y22V0E	F312115MDX	500	16	23.5	7.3	7.9	1.9-1P	38.0	43.0	28.5	5	H
LDFW020412Y22V0E			20	13.2	4.1	4.9	2.1-1P					
LDFW025232Y22V0E			25	7.4	2.3	3.1	1.6-2P					
LDFW032142Y22V0E			32	4.5	1.4	1.9	1.8-2P					
LDFW020592YJUV0E	F372315MUDX	700	20	19.0	5.9	5.7	1.5-2P	48.0	50.0	32.5	6	I
LDFW027282YJUV0E			27	9.0	2.8	3.1	1.7-2P					
LDFW039172YJUV0E			39	5.5	1.7	1.8	2.0-2P					
LDFW030392Y28V0E	F443420MDX	600	30	12.6	3.9	3.6	2.0-2P	53.0	59.5	39.0	7	J
LDFW036262Y28V0E			36	8.4	2.6	2.5	2.2-2P					

\* The inductance at 10kHz indicates the reference value.

For single-phase circuit

◆FREQUENCY CHARACTERISTICS AMBIENT TEMPERATURE:25°C

● Impedance

● Inductance

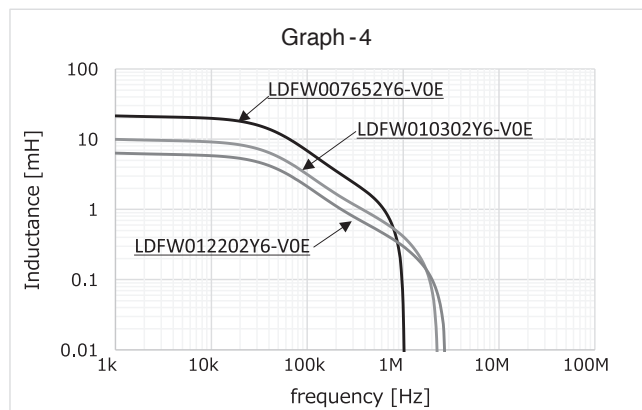
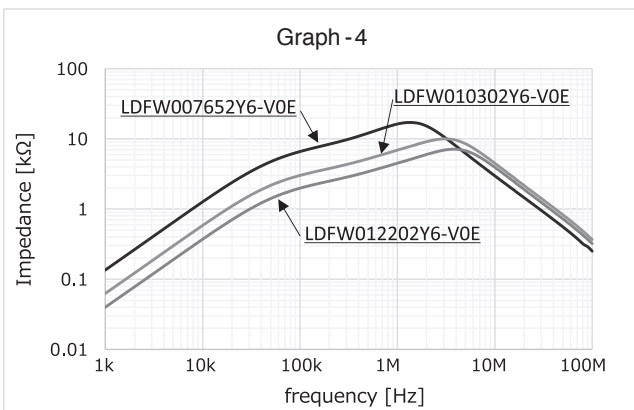
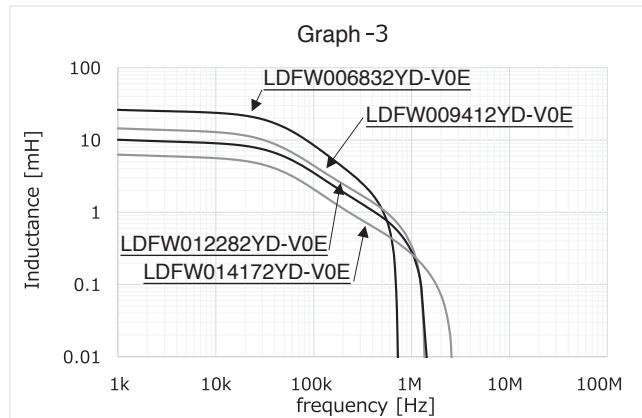
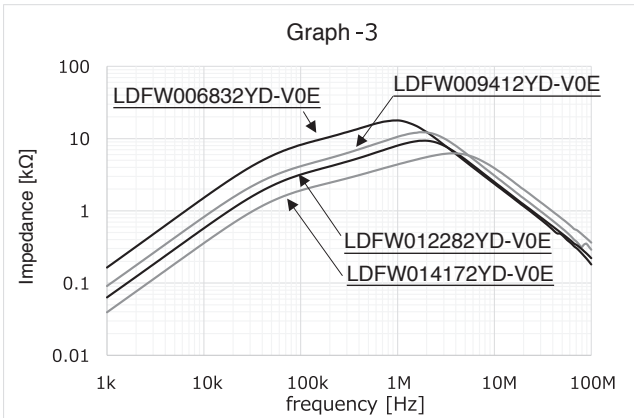
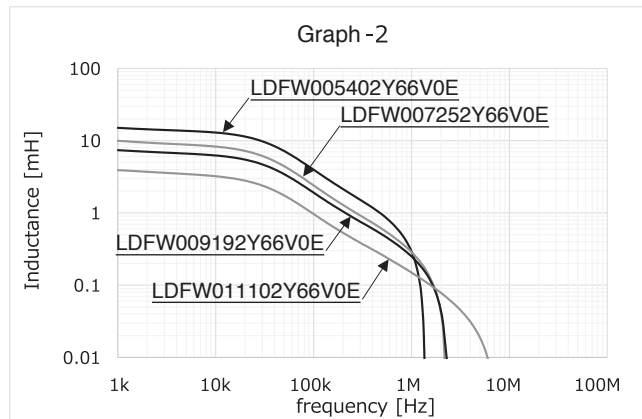
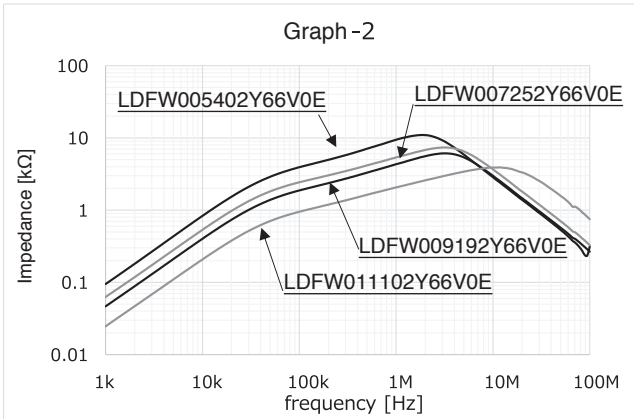
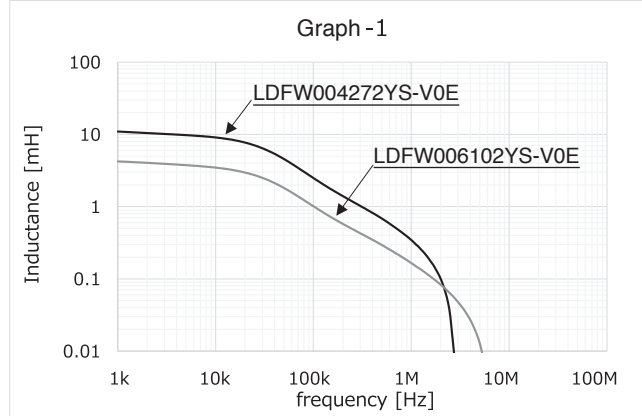
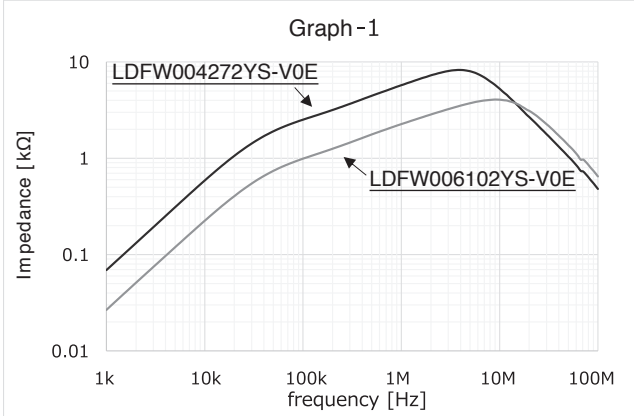

FOR SINGLE-PHASE CIRCUIT

◆FREQUENCY CHARACTERISTICS AMBIENT TEMPERATURE:25°C

●Impedance

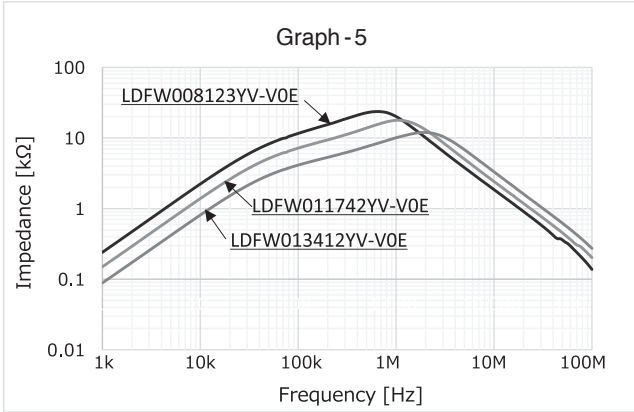

●Inductance

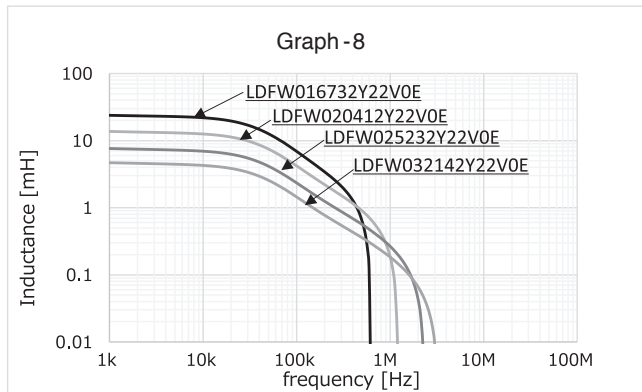
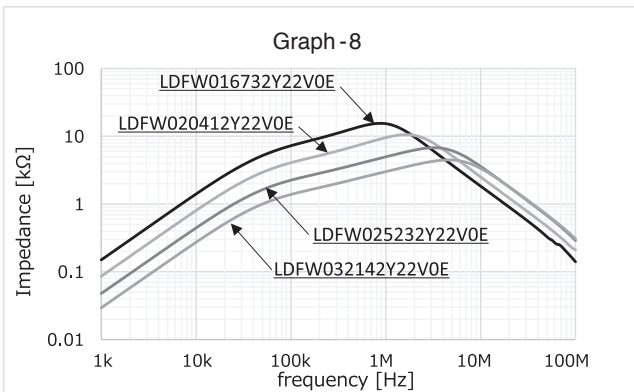
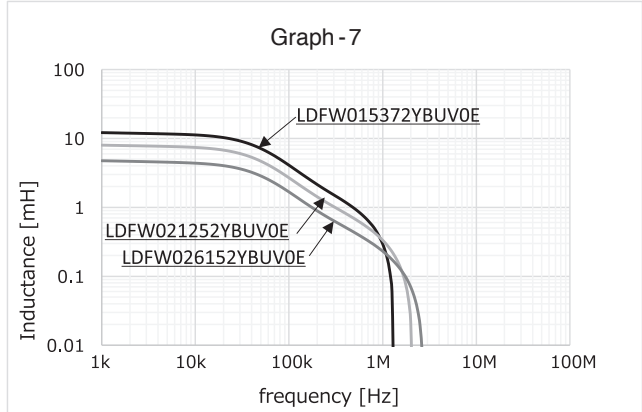
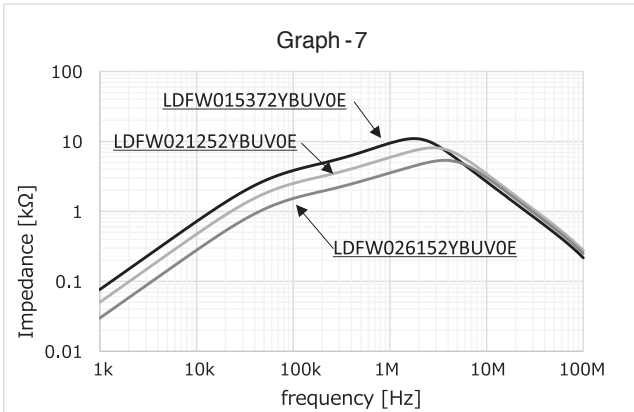
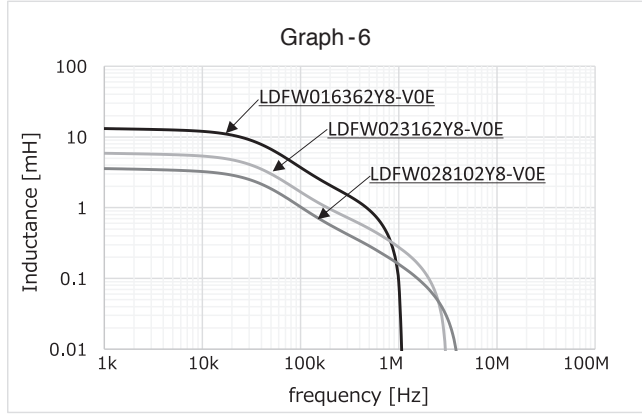
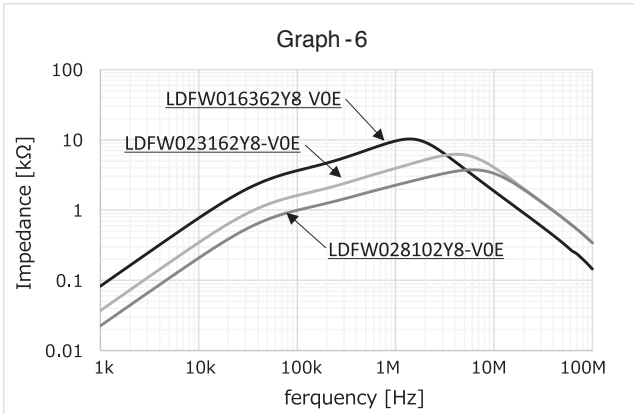
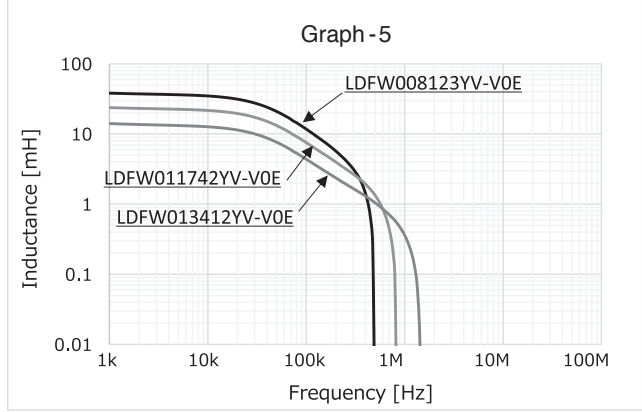

For single-phase circuit

◆ FREQUENCY CHARACTERISTICS AMBIENT TEMPERATURE: 25°C

● Impedance

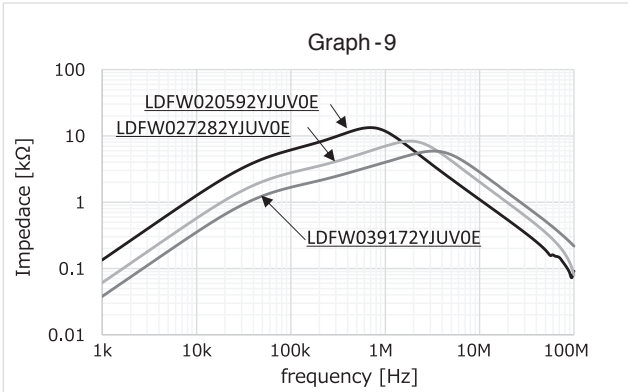

● Inductance

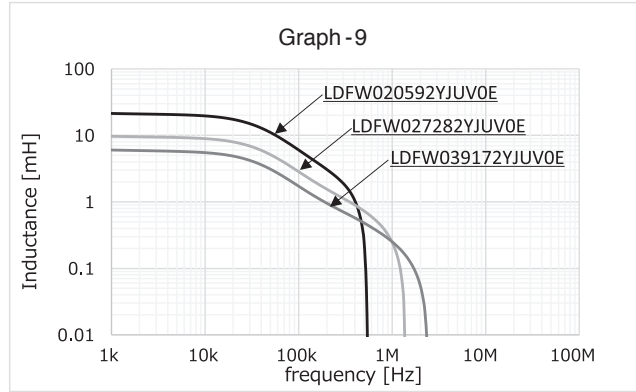

Graph - 10

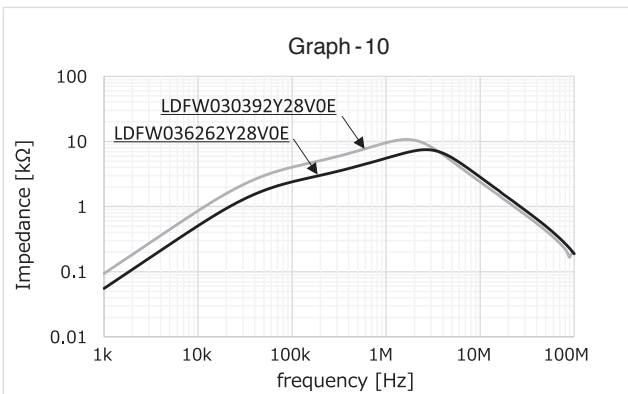

Graph - 10

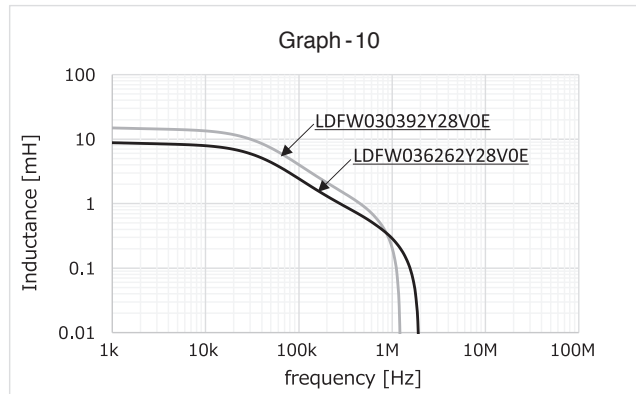

For single-phase circuit

◆RISE TEMPERATURE: AMBIENT TEMPERATURE=25°C SATURATED TEMPERATURE DUE TO DC CURRENT APPLICATION.

\*This data don't consider set situation, influence of around parts.

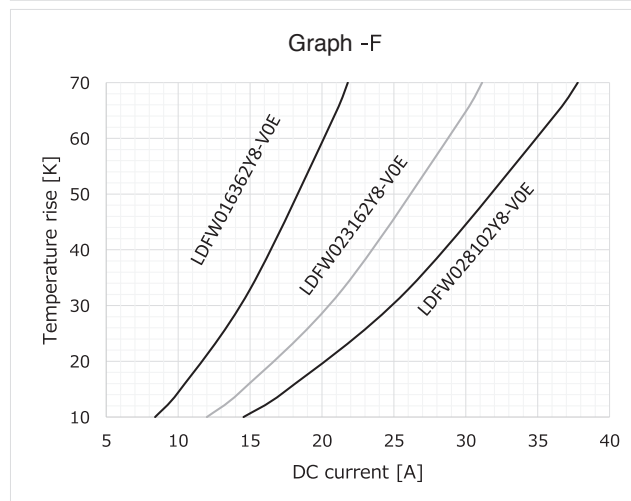
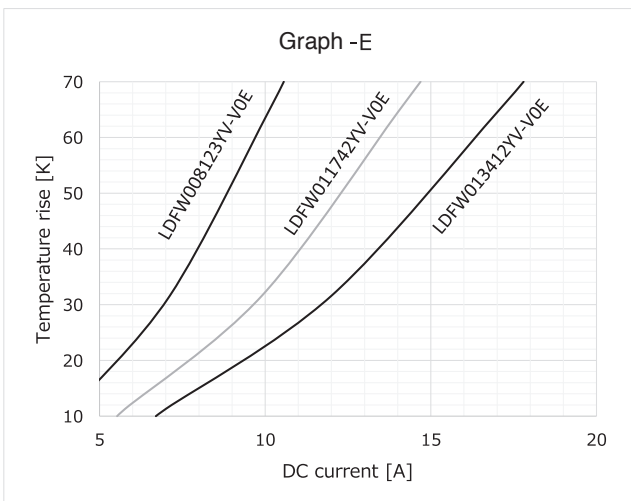
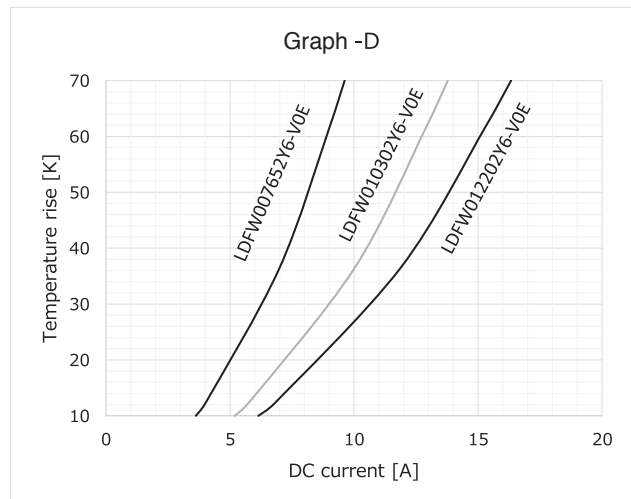
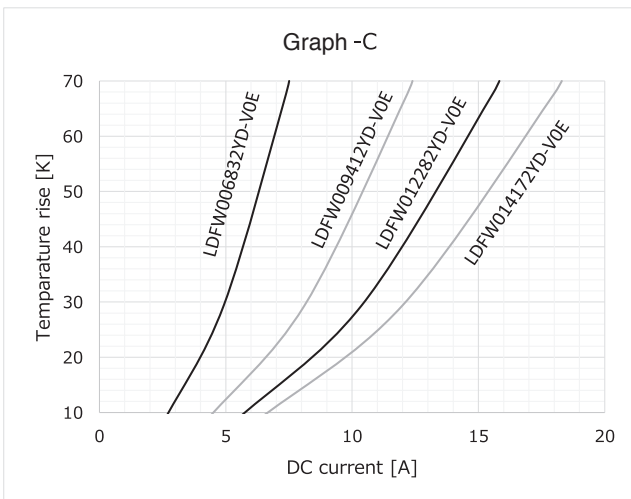
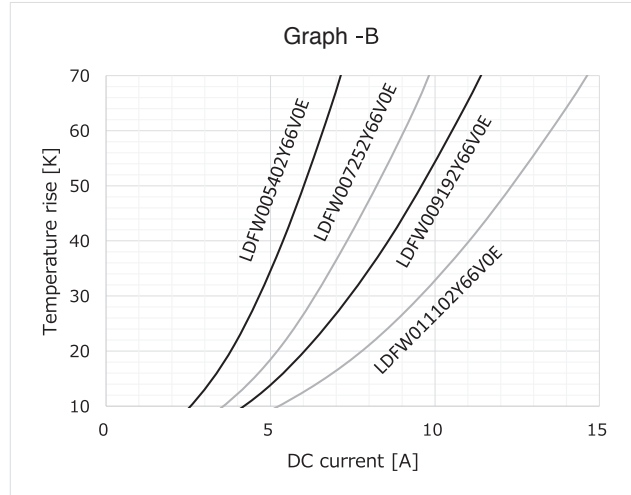
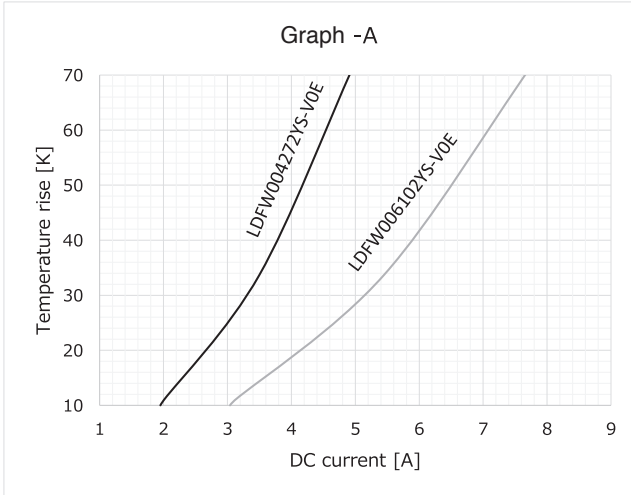

For single-phase circuit

◆RISE TEMPERATURE: AMBIENT TEMPERATURE=25°C SATURATED TEMPERATURE DUE TO DC CURRENT APPLICATION.

\*This data don't consider set situation, influence of around parts.

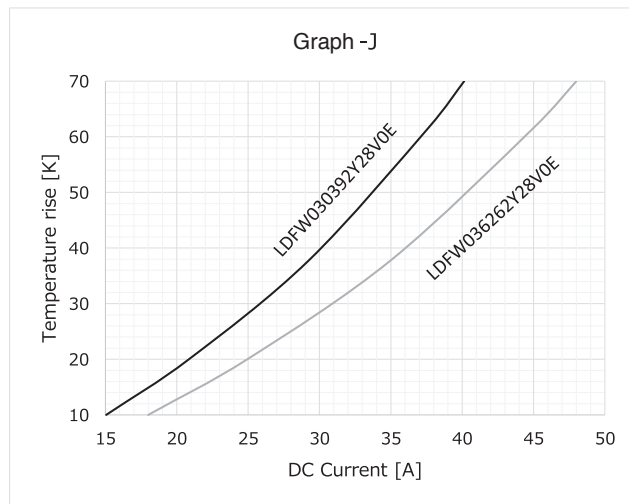
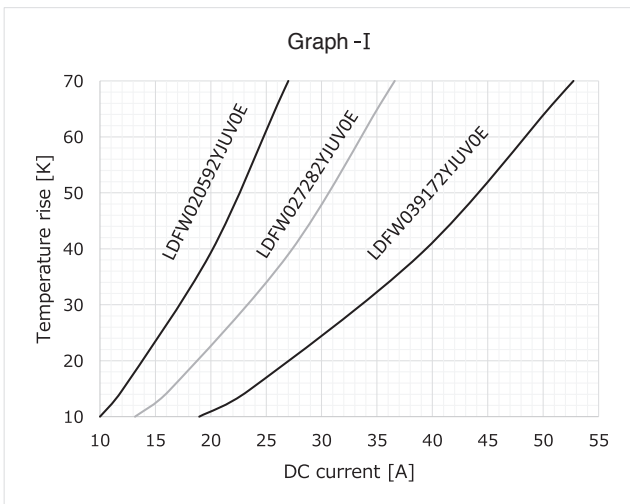
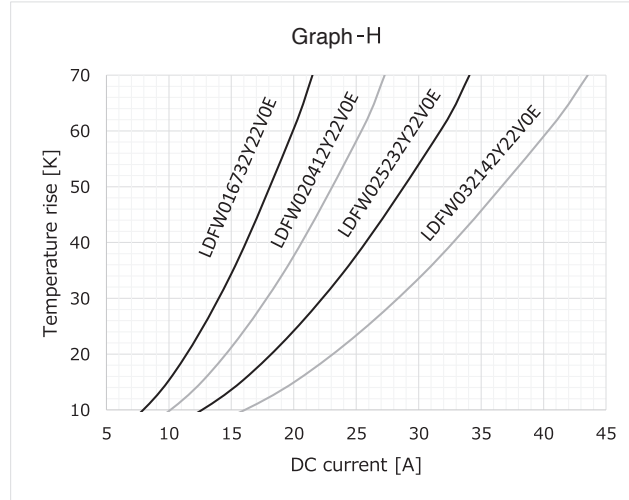
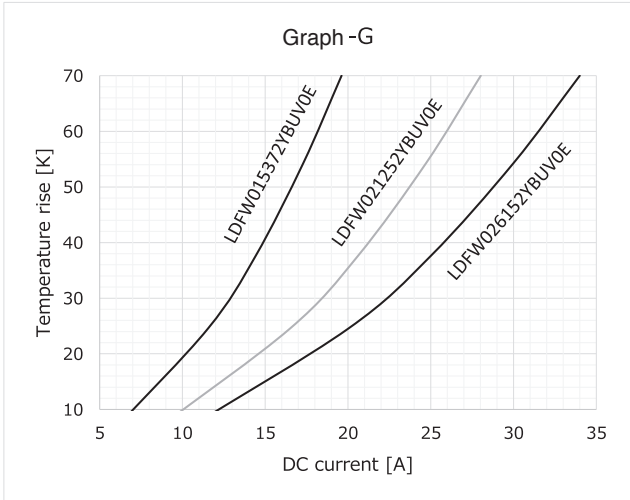

## Precautions and Guidelines

- The lead wires are made of copper. Please take care not to apply excessive force or repeatedly bend them.
- Do not allow the coil to come into contact with hard or sharp objects. Doing so may damage the coating and impair performance.
- The heat resistance temperature of 130°C is the rated temperature, which includes the heat generated by the coil itself.
- In high-temperature and high-humidity environments, hydrolysis may cause the wire coating to degrade, leading to insulation deterioration.
- Common-mode coils may experience magnetic saturation due to unbalanced current.
- Safety standards have not been obtained for the coil alone.

For three-phase circuit

◆ **MAJOR USES**

- Noise filter for inverter and large-capacity power supply

◆ **FEATURES**

- Greatly improved inductance (10kHz, 100kHz).
- Improved impedance in the 150 kHz to 1 MHz frequency band when compared to the FL-V series coils.

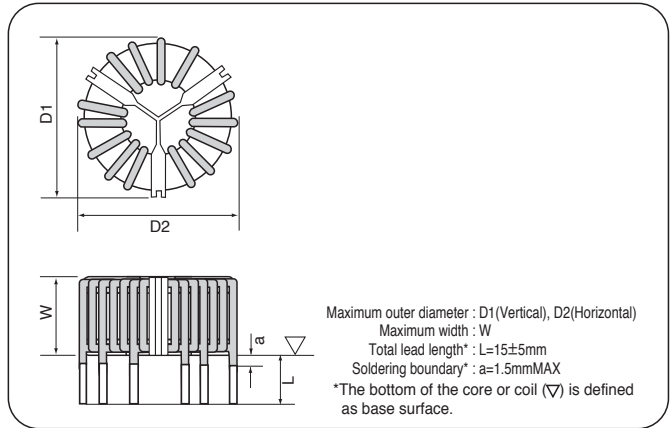

Coil Part No.	Core Part No.	Rated voltage [V]	Rated Current [A]	Inductance		D.C.R. mΩ (max)	Winding mm φ -lines	Outside Dimensions			Frequency Characteristics Graph	Temperature rise Graph
				10kHz [mH]	100kHz [mH]			D1 [mm]	D2 [mm]	W [mm]		
LDFW010642Y74H0E	F312115MDX	500	10	20.7	6.4	13.0	1.4-1P	42.0	42.0	27.5	1	A
LDFW015342Y74H0E			15	11.1	3.4	6.6	1.7-1P					
LDFW020142Y74H0E			20	4.5	1.4	3.1	2.0-1P					
LDFW015422YJQH0E	F372315MDX	500	15	13.5	4.2	6.4	1.8-1P	48.5	48.5	29.0	2	B
LDFW020282YJQH0E			20	9.0	2.8	4.5	2.0-1P					
LDFW025172YJQH0E			25	5.5	1.7	2.6	2.3-1P					
LDFW030132YJQH0E			30	4.0	1.3	2.0	2.3-1P					
LDFW020502Y72H0E	F422615MDX	500	20	16.2	5.0	5.6	2.1-1P	56.0	56.0	32.0	3	C
LDFW025282Y72H0E			25	9.1	2.8	3.6	2.3-1P					
LDFW030172Y72H0E			30	5.5	1.7	2.4	1.8-2P					
LDFW035132Y72H0E			35	4.0	1.3	1.7	2.0-2P					
LDFW030332Y73H0E	F503415MDX	500	30	10.6	3.3	3.0	2.0-2P	65.0	65.0	35.0	4	D
LDFW035222Y73H0E			35	7.1	2.2	2.3	2.1-2P					
LDFW040172Y73H0E			40	5.6	1.7	1.9	2.2-2P					
LDFW050102Y73H0E			50	3.2	1.0	1.2	2.4-2P					

\* The inductance at 10kHz indicates the reference value.

For three-phase circuit

◆ FREQUENCY CHARACTERISTICS AMBIENT TEMPERATURE: 25°C

● Impedance

● Inductance

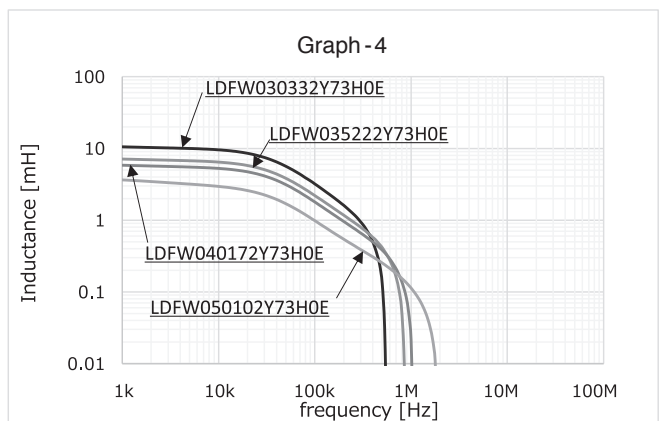
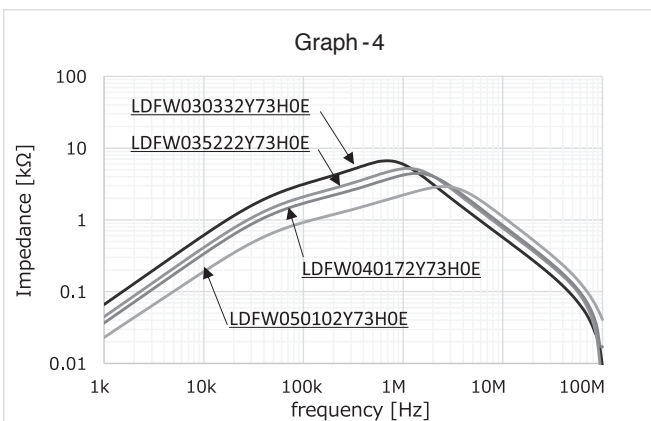
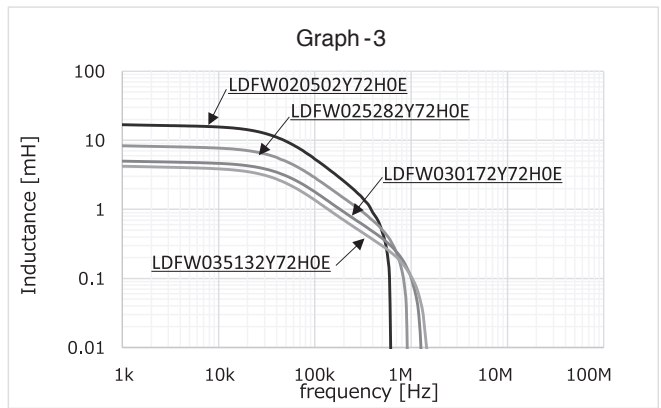
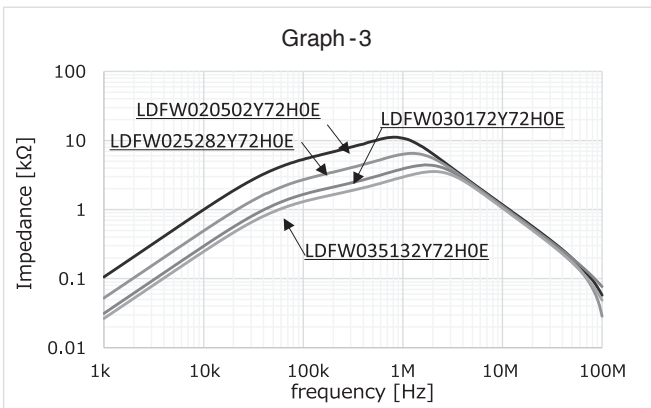
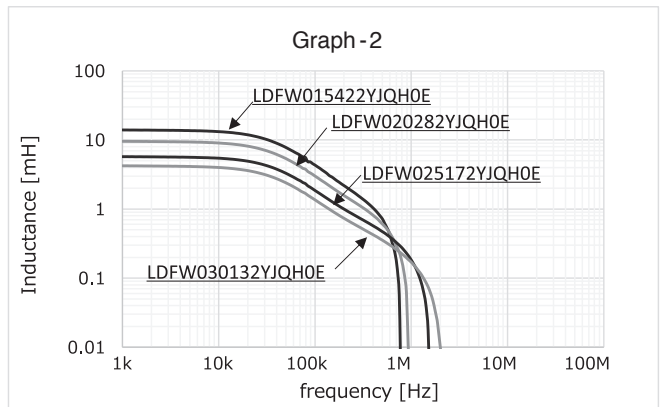
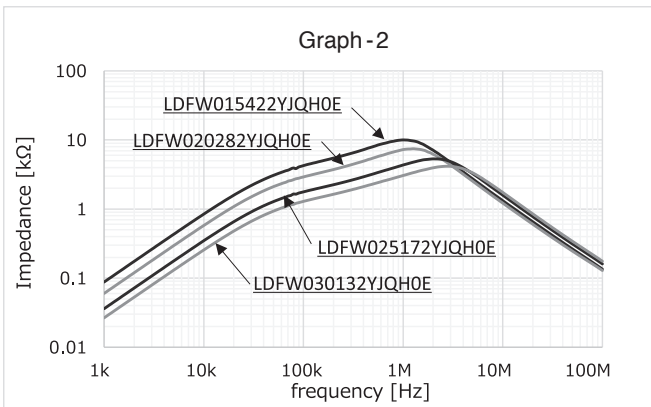
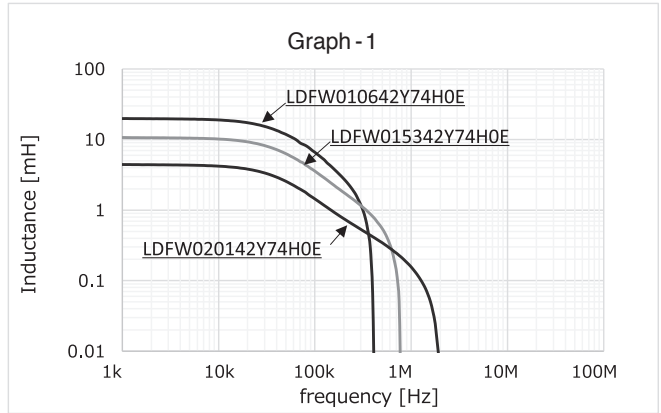
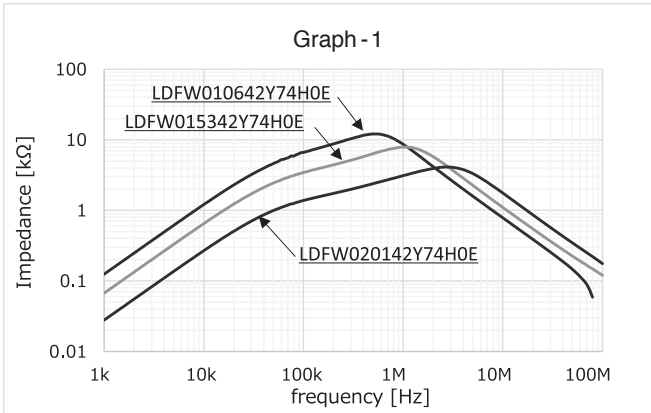

For three-phase circuit

◆RISE TEMPERATURE: AMBIENT TEMPERATURE=25°C SATURATED TEMPERATURE DUE TO DC CURRENT APPLICATION.

\*This data don't consider set situation,influence of around parts.

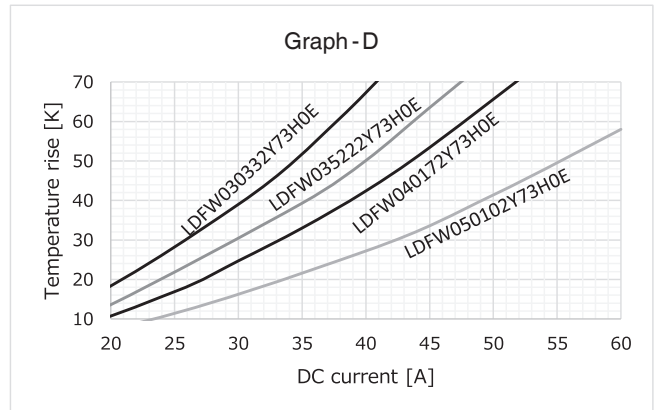
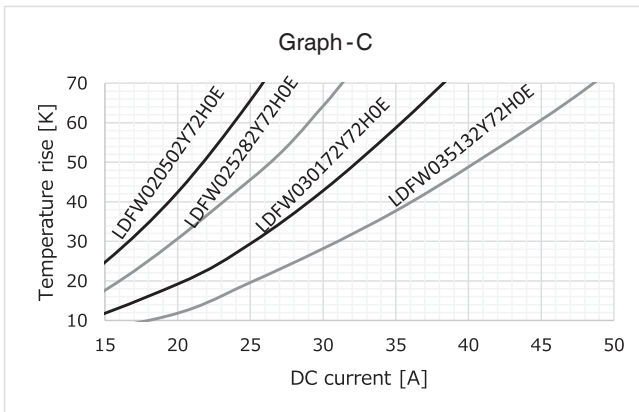
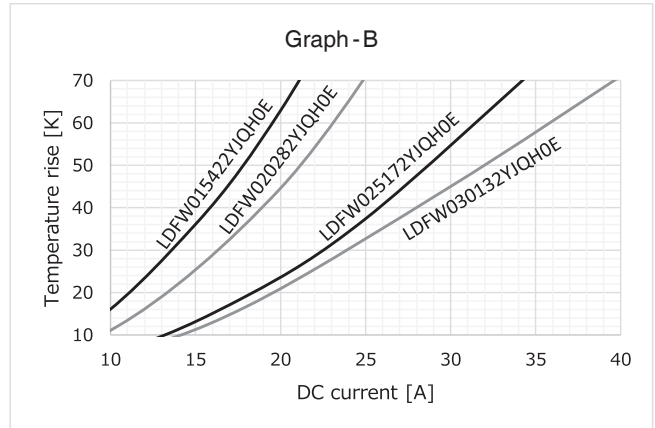
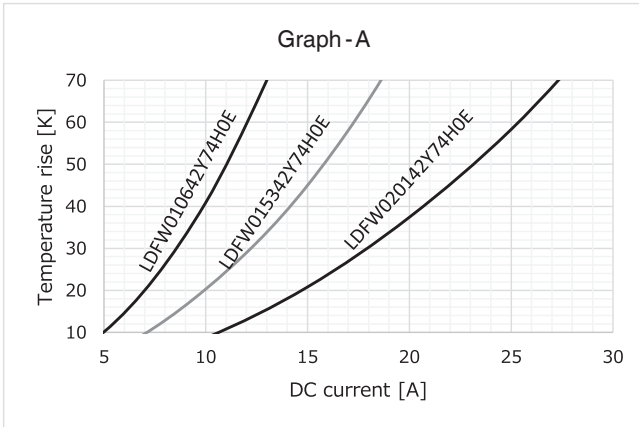



- Always read "Notes on Use" before using the product in order to enable you to use the product correctly and prevent any faults and accidents from occurring.
- Request the Product Specification on the product of NIPPON CHEMI-CON CORPORATION to refer to it as well as this brochure prior to the order of the products. Some specific notes on use of the ordered product may be described in the specifications.
- The products listed in this catalog are designed and manufactured for general electronics equipment use and are not intended for use in applications that can adversely affect human life; where the malfunction of equipment may cause damage to life or property. In addition, our products are not intended to be used in specific applications that may cause a major social impact. Please consult with us in advance of usage of our products in the following listed applications. ① Aerospace equipment ② Power generation equipment such as thermal power, nuclear power etc. ③ Medical equipment ④ Transport equipment (automobiles, trains, ships, etc.) ⑤ Transportation control equipment ⑥ Disaster prevention / crime prevention equipment ⑦ Highly publicized information processing equipment ⑧ Submarine equipment ⑨ Other applications that are not considered general-purpose applications.
- The circuits described as examples in this catalog and the "delivery specifications" are featured in order to show the operations and usage of our products, however, this fact does not guarantee that the circuits are available to function in your equipment systems. We are not in any case responsible for any failures or damage caused by the use of information contained herein. You should examine our products, of which the characteristics are described in the "delivery specifications" and other documents, and determine whether or not our products suit your requirements according to the specifications of your equipment systems. Therefore, you bear final responsibility regarding the use of our products.  
Please make sure that you take appropriate safety measures such as use of redundant design and malfunction prevention measures in order to prevent fatal accidents and/or fires in the event any of our products malfunction.
- We strongly recommend our customers to purchase Nippon Chemi-Con products only through our official sales channels. We assume no responsibility for any defects or damages caused by using products purchased from outside our official sales channel or of counterfeit goods. In addition, we will ask the customer to pay the investigation cost for products purchased outside our official sales channel.
- We reserve the right to discontinue production and delivery of products. We do not guarantee that all the products included in this catalog will be available in the future.  
The aforementioned does not apply in the case of individual agreements deviating from the foregoing for customer-specific products
- We continually strive to improve the quality and reliability of our products, but in any case that our product does not meet our published specifications, please stop using it promptly and contact us immediately. As for compensation for non-conforming goods delivered by Chemi-Con, we will limit it only to goods found in non-compliance of our published specifications. This may be accomplished by a no cost replacement of non-conforming individual products, a credit of the piece price paid per each individual non-conforming product, or in other ways deemed necessary.  
In addition, we have an established system with enhanced traceability, therefore we will limit the applicable lot items for any potential compensation.

[Accessory](#)

[Standard Specifications · Precautions and Guidelines](#)

[Minimum Order Quantity](#)

[Characteristics](#)

[Coil Design Request](#)



## Notes on Use

- The indicated heat-resistant temperatures are the guaranteed temperatures including coil self-generated heat.
- In high-temperature,-humidity environment, There is a possibility to occur hydrolyze and insulation deterioration.
- Common mode coils, by the unbalanced current, it may cause a magnetic saturation.
- We do not acquire safety standards with coil only.
- Ensure that you do not repeatedly apply excessive force to the lead wires or repeatedly bend them.
- Do not bang the coil against hard objects. Scratch on the coating, possibly impairing performance.
- Contact NIPPON CHEMI-CON for how to clean the substrate on which the coil is mounted.
- When infra-acoustic frequency component is impressed, a beat sound sometimes occurs.
- The products described in this catalog have been designed and manufactured for general electronic devices, therefore, if you intend to use our products for purposes that may endanger or threaten human lives and cause damage to property if such electronic devices fail or malfunction, or have a significant impact on society, please contact our information counter in advance to consult with us before using our products.
- Response to the Substances of Concern
  - (1) Nippon Chemi-Con aims for developing products that meet laws and regulations concerning substances of concern.  
(Some products may contain regulated substances for exempted application.)  
Please contact us for more information about law-compliance status.
  - (2) According to the content of REACH handbook (Guidance on requirements for May 2008), our electronic components are "articles without any intended release". Therefore they are not applicable for Registration for EU REACH Regulation Article 7 (1).  
Reference: Electrolytic Condenser Investigation Society  
Study of REACH Regulation in EU about Electrolytic Capacitor (publicized on 13 March 2008)

## Inductor (Coil) AEC-Q200 Compliance

The Automotive Electronics Council (AEC) was originally established by major American automotive related manufactures. Today, it is composed of representatives from the manufacturing companies in automotive electronic devices and components. It standardizes the certification criteria and reliability tests for electronic components.

AEC-Q200 is the reliability test standard for approval of passive components in automotive applications. It specifies the test type, parameters, quantity, etc. for each component. The criteria used in reliability tests for "Inductors(Coils/Cores)" are described in this standard.

Pursuant to the customer's specific testing requirements, Chemi-Con submits the test results according to AEC-Q200 for Inductors(Coils/Cores) used in automotive applications on request.

An electronic component manufacturer cannot simply claim that their product is "AEC-Q200 Qualified". Instead, the manufacturer may claim their components as "Compliant", "Capable", "Available", etc.

Each component must be tested depending on the customer's "Qualification Test Plan" in order to claim AEC-Q200 Qualification.

The standard products listed in the catalog are designed for general electronic equipment. If you are considering using the products for automotive use, it may be necessary to change the specifications. Please contact our sales representative for more information.