

Main Product Characteristics

$V_{(BR)DSS}$	100V
$R_{DS(ON)}$	4.0m Ω (Max.)
I_D	180A

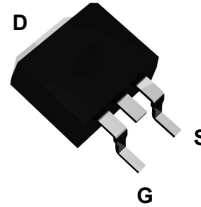

TO-263 (D²PAK)

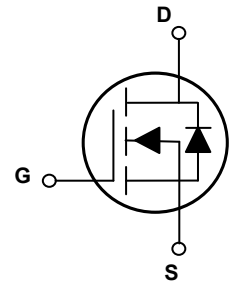

Schematic Diagram

Features and Benefits

- Advanced MOSFET process technology
- Ideal for high efficiency switched mode power supplies
- Low on-resistance with low gate charge
- Fast switching and reverse body recovery



Description

The GSFT4R010 utilizes the latest techniques to achieve high cell density and low on-resistance. These features make this device extremely efficient and reliable for use in high efficiency switch mode power supplies and a wide variety of other applications.

Absolute Maximum Ratings (T_C=25°C unless otherwise specified)

Parameter	Symbol	Value	Unit
Drain-Source Voltage	V _{DS}	100	V
Gate-to-Source Voltage	V _{GS}	±20	V
Continuous Drain Current, @ Steady-State (T _C =25°C) ¹	I _D	180	A
Continuous Drain Current, @ Steady-State (T _C =100°C)		108	A
Pulsed Drain Current ²	I _{DM}	720	A
Power Dissipation (T _C =25°C)	P _D	442	W
Linear Derating Factor (T _C =25°C)		2.94	W/°C
Single Pulse Avalanche Energy ³	E _{AS}	484	mJ
Thermal Resistance, Junction-to-Case	R _{θJC}	0.34	°C/W
Thermal Resistance, Junction-to-Ambient (PCB Mounted, Steady-State) ⁴	R _{θJA}	62.5	°C/W
Operating Junction and Storage Temperature Range	T _J /T _{STG}	-55 to +175	°C

Electrical Characteristics ($T_A=25^\circ\text{C}$ unless otherwise specified)

Parameter	Symbol	Conditions	Min.	Typ.	Max.	Unit
On / Off Characteristics						
Drain-to-Source Breakdown Voltage	$V_{(BR)DSS}$	$V_{GS}=0V, I_D=250\mu A$	100	-	-	V
Drain-to-Source Leakage Current	I_{DSS}	$V_{DS}=100V, V_{GS}=0V$	-	-	1	μA
		$T_J=125^\circ\text{C}$	-	-	50	
Gate-to-Source Forward Leakage	I_{GSS}	$V_{GS}=20V$	-	-	100	nA
		$V_{GS}=-20V$	-	-	-100	
Static Drain-to-Source On-Resistance	$R_{DS(ON)}$	$V_{GS}=10V, I_D=50A$	-	3.45	4	m Ω
Gate Threshold Voltage	$V_{GS(th)}$	$V_{DS}=V_{GS}, I_D=250\mu A$	2.2	3	3.9	V
Dynamic and Switching Characteristics						
Input Capacitance	C_{iss}	$V_{GS}=0V, V_{DS}=50V,$ $F=1\text{MHz}$	-	8200	-	pF
Output Capacitance	C_{oss}		-	930	-	
Reverse Transfer Capacitance	C_{rss}		-	36	-	
Total Gate Charge	Q_g	$I_D=20A, V_{DS}=50V,$ $V_{GS}=10V$	-	140	-	nC
Gate-to-Source Charge	Q_{gs}		-	45	-	
Gate-to-Drain ("Miller") Charge	Q_{gd}		-	39	-	
Turn-on Delay Time	$t_{d(on)}$	$V_{GS}=10V, V_{DS}=50V,$ $R_L=1\Omega, R_{GEN}=3\Omega,$ $I_D=50A$	-	41	-	nS
Rise Time	t_r		-	60	-	
Turn-Off Delay Time	$t_{d(off)}$		-	89	-	
Fall Time	t_f		-	36	-	
Gate Resistance	R_g	$F=1\text{MHz}$	-	1.9	-	Ω
Source-Drain Ratings and Characteristics						
Continuous Source Current (Body Diode)	I_S	MOSFET symbol showing the integral reverse p-n junction diode.	-	-	120	A
Pulsed Source Current (Body Diode)	I_{SM}		-	-	480	A
Diode Forward Voltage	V_{SD}	$I_S=50A, V_{GS}=0V$	-	1	1.2	V
Reverse Recovery Time	T_{rr}	$T_J=25^\circ\text{C}, I_F=50A,$ $di/dt=100A/\mu s$	-	78	-	nS
Reverse Recovery Charge	Q_{rr}		-	0.2	-	μC

Note:

1. Pulse test: pulse width $\leq 300\mu s$, duty cycle $\leq 2\%$.
2. Repetitive rating; pulse width limited by max. junction temperature.
3. $L=0.5\text{mH}, I_{AS}=44A, V_{DD}=80V, T_J=25^\circ\text{C}$.
4. Device mounted on FR-4 PCB, 1 inch x 0.85 inch x 0.062 inch.

Typical Electrical and Thermal Characteristic Curves

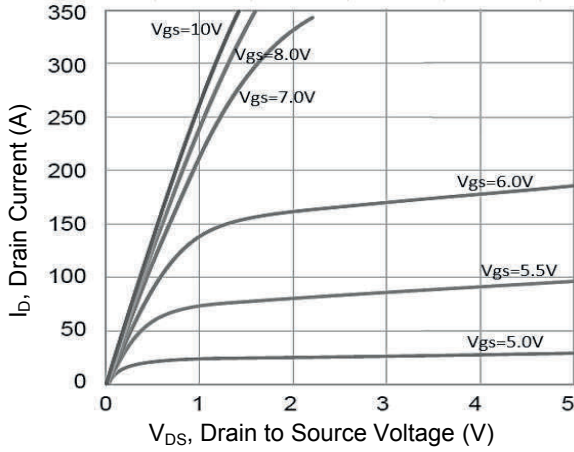

Figure 1. Typical Output Characteristics

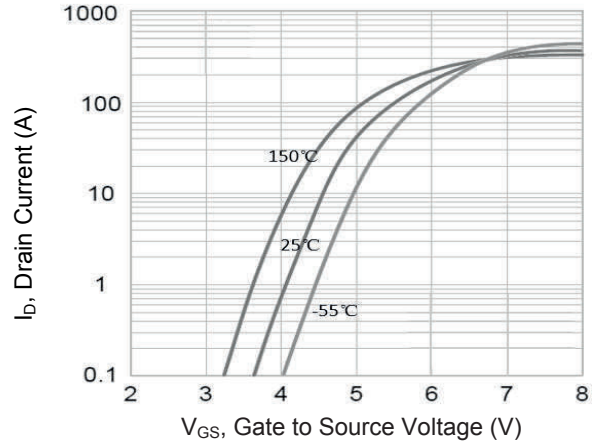

Figure 2. Transfer Characteristics

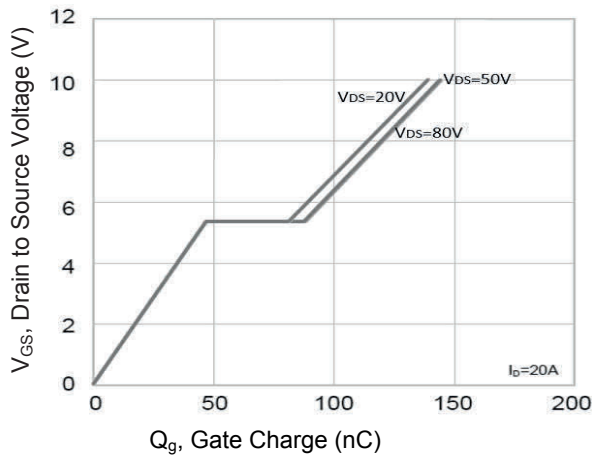

Figure 3. Gate Charge

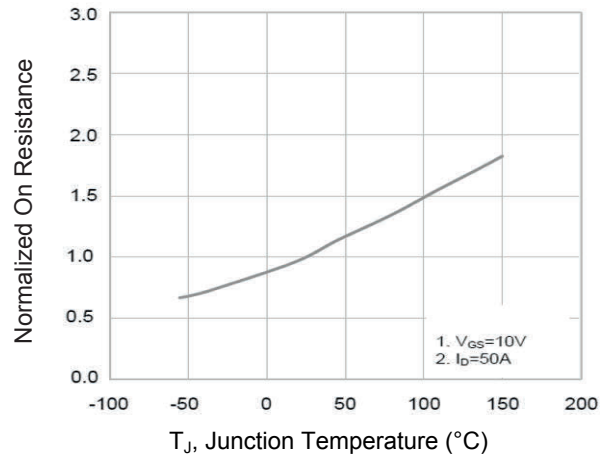

Figure 4. Normalized On-Resistance vs. T_J

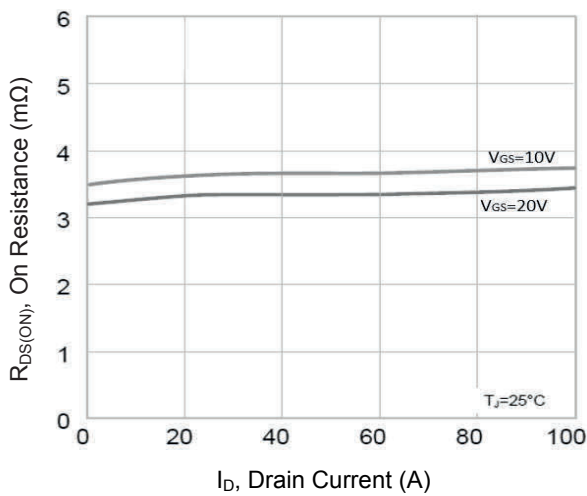

Figure 5. Drain to Source On-Resistance vs. I_D

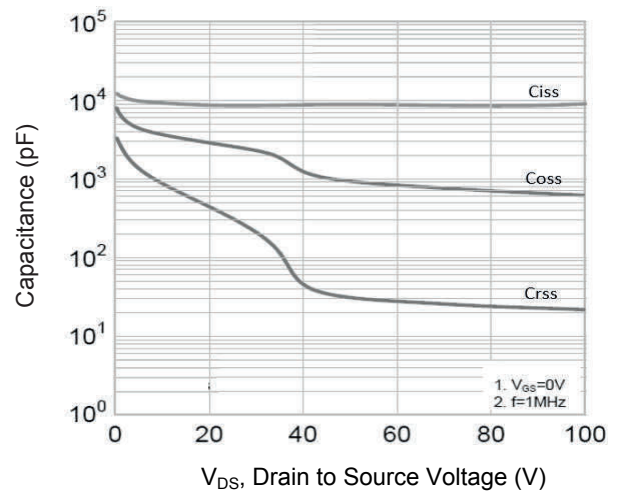

Figure 6. Typical Capacitance Characteristics

Typical Electrical and Thermal Characteristic Curves

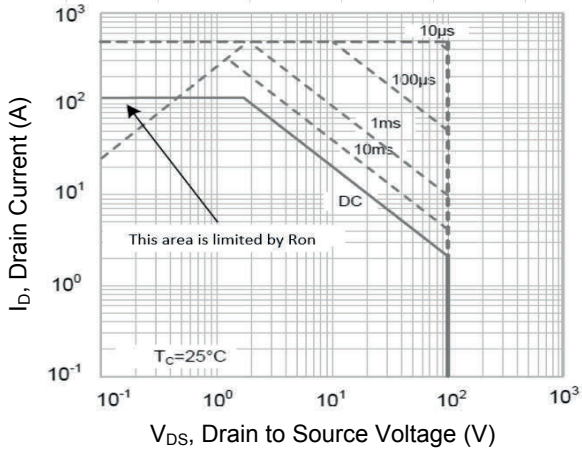

Figure 7. Safe Operation Area

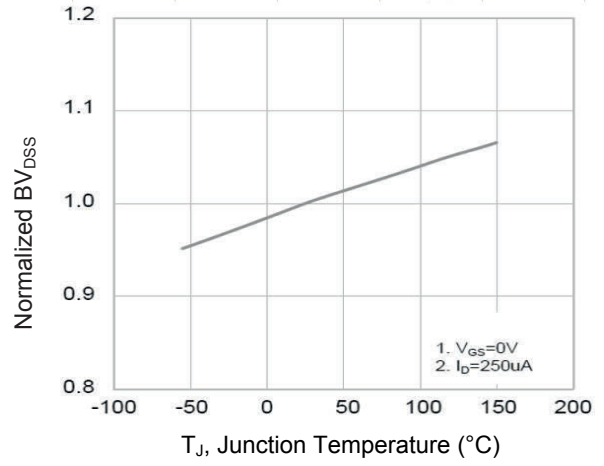
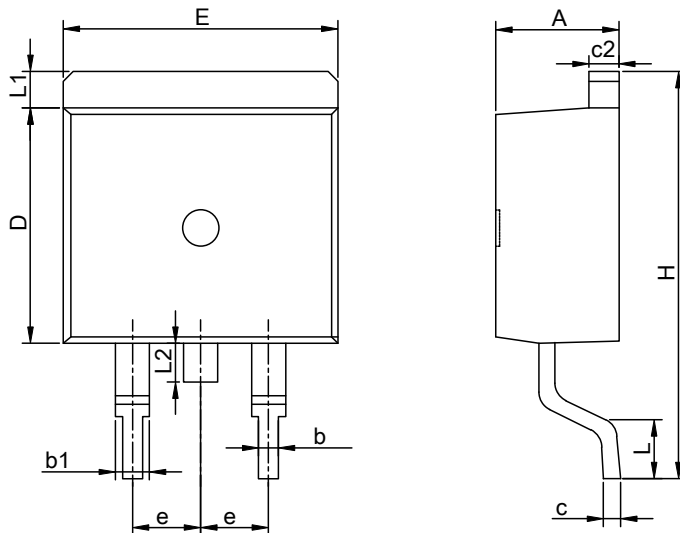

Figure 8. Normalized BV_{DSS} vs. T_J

Package Outline Dimensions TO-263 (D²PAK)



Symbol	Dimensions In Millimeters		Dimensions In Inches	
	Min.	Max.	Min.	Max.
A	4.30	4.90	0.169	0.193
b	0.70	0.95	0.028	0.037
b1	1.07	1.50	0.042	0.059
c	0.28	0.60	0.011	0.024
c2	1.17	1.37	0.046	0.054
D	8.40	9.35	0.331	0.368
E	9.80	10.45	0.386	0.411
e	2.54 BSC		0.100 BSC	
H	14.70	16.30	0.579	0.642
L	2.00	3.80	0.079	0.150
L1	0.97	1.42	0.038	0.056
L2	-	1.75	-	0.069

Order Information

Device	Package	Marking	Packaging	SPQ
GSFT4R010	TO-263 (D ² PAK)	T4R010	Tape & Reel	800 Pcs / Reel

For more information, please contact us at: inquiry@goodarksemi.com